

Bohrschablone für Deckenhalter

Seitenansicht

Abmessung für Abhängseil

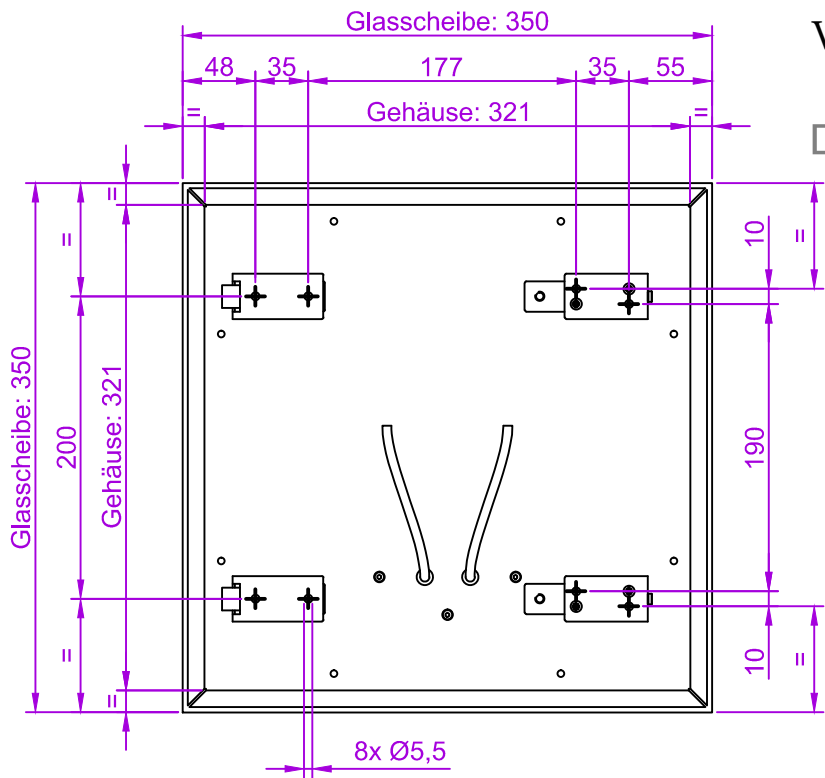

VH

Detail A

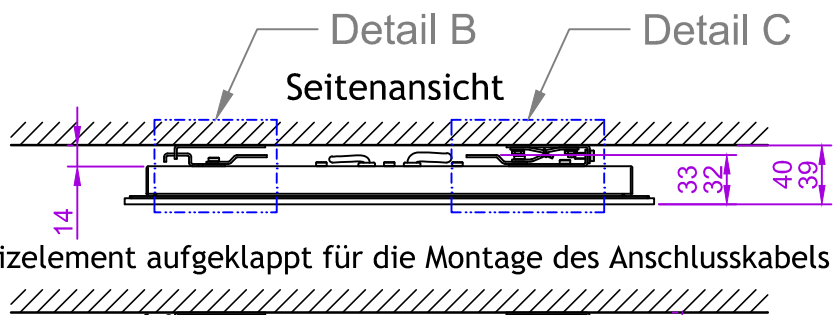
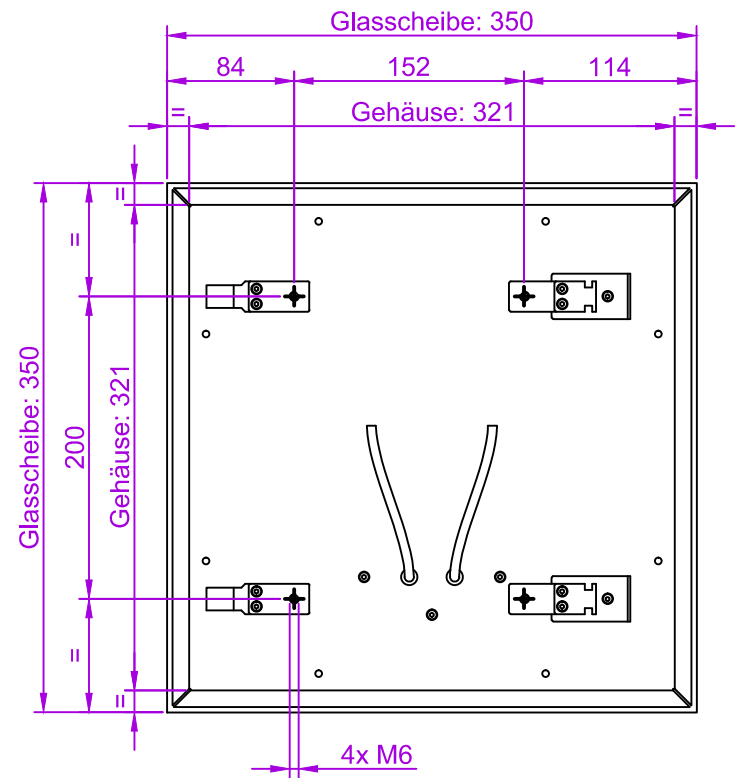
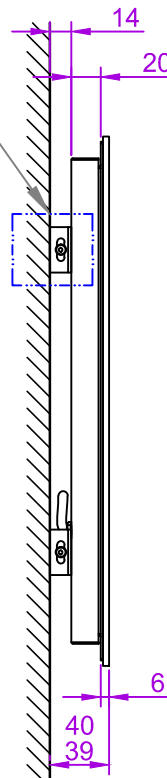

Heizelement aufgeklappt für die Montage des Anschlusskabels

Detail A (Maßstab 1:1)

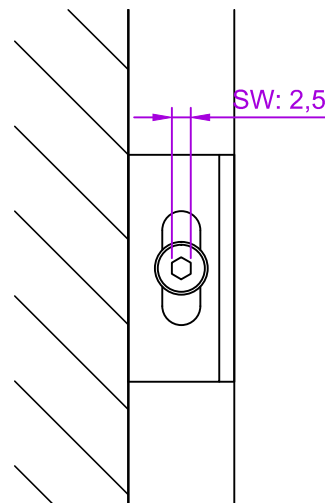

Detail B (Maßstab 1:1)

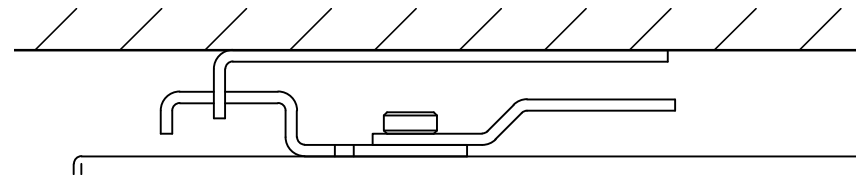

Detail C (Maßstab 1:1)

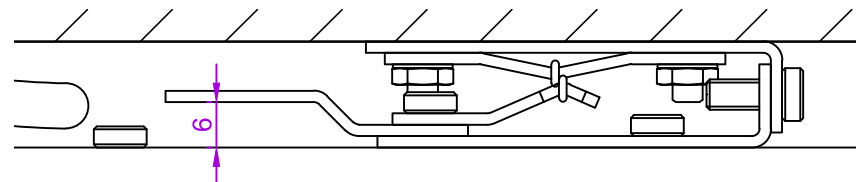

230  
210

Item	Quantity	Title/Name, material, dimension		Article No./Reference		
Designed by: PR	Checked by: -	Date: 14.10.2010	Project: VH0300	Unit: mm	Scale: 1:5	A4
<b>Vitramo</b> <small>Am Bild 58                      D-97941 Tauberbischofsheim                      info@vitramo.com</small>		 <small>feel comfortable</small>		Title: <b>Montage</b> Number: <b>2010-107</b>		
				Version: A	Sheet: 1/1	